



Wells-Gardner Electronics Corporation

# **User Manual for D9400 D9410 Series Digital-Control Color Monitor**

**Wells-Gardner Electronics  
9500 W. 55th Street Suite A  
Mc Cook, Il. 60525-3605  
(708) 290-2100**

Revision ORG/E11004  
D9400 User manual  
Date 2-10-06

| Drawn By:             | Checked / Date        | Approved / Date       |
|-----------------------|-----------------------|-----------------------|
| Lee Sutton<br>2/10/06 | Lee Sutton<br>2/10/06 | Lee Sutton<br>2/10/06 |



## Wells-Gardner Electronics Corporation

### Picture Tube.

- **Size: 27V Regular and Flat size to customer requirement**
- **Dot Pitch: .83mm**

### Signal Input.

- **Video Input: Analog, Positive Signal 4 / 2.2Volts CGA (0.7V p-p)VGA**
- **Horizontal Sync: TTL Level, Positive or Negative Pulse**
- **Scanning : 15.75 KHz-50KHz**
- **Vertical Input: TTL Level, Positive or Negative pulse**
- **Scanning : 40-100Hz**

### Power Supply.

- **Power Input : 90-240 VAC, 50/60Hz**
- **Fuse Rating: 250V, 3.15A**
- **Power Consumption**  
Normal : less than 150W

### OSD (On Screen Display) Control:

**Operating Temperature: 0°C - 55°C**

**Operating Humidity: 10% - 90% (Noncondensing)**

**Net Weight : 17kg (37lbs) Standard frame**

### TECHNICAL FEATURES:

**Microprocessor control with OSD (On screen display menu).**

**Microprocessor recognizes the input computer signal and signal output from the customer control board connected to the main board by a flat cable.**

**Universal AC Input Voltage.**

**Power supply operates on 90-240 VAC at 60/50Hz for use all over the world.**

**A (NO SIGNAL IN) message is displayed on the screen if no signal is present at the signal-input cable while the monitor is powered on.**

**Control panel.**

**If you require different display characteristics other than the factory mode presets of size, position, color settings, use the control panel to program it to your requirements in each resolution mode. These adjusted settings are kept in memory even if you change resolution mode or turn off the monitor.**



**FEATURES:**

**I<sup>2</sup>C BUS control.**

The monitor is designed with I<sup>2</sup>C BUS control for simplifying the circuitry.

Automatic mode recognition of preset factory modes

No control pots to wear out

**SET UP:**

Setting up your monitor is easy. All you have to do is make a few simple connections and adjustments. The procedure is as follows:

**START UP:**

Your monitor starts up automatically when you insert the power plug to power source.

**Signal Cable Connection.**

Connect the 15pin-signal cable to the source and lock both screws to ensure that the monitor is properly grounded.

**D type 15pin connector:**

| PIN NO. | DESCRIPTION        | PIN NO. | DESCRIPTION |
|---------|--------------------|---------|-------------|
| 1       | VIDEO RED          | 9       | N.C.        |
| 2       | VIDEO GREEN        | 10      | GROUND      |
| 3       | VIDEO BLUE         | 11      | N.C.        |
| 4       | N.C.               | 12      | SDA         |
| 5       | N.C.               | 13      | HOR-SYNC    |
| 6       | VIDEO RED GROUND   | 14      | VER-SYNC    |
| 7       | VIDEO GREEN GROUND | 15      | SCL         |
| 8       | VIDEO BLUE GROUND  |         |             |

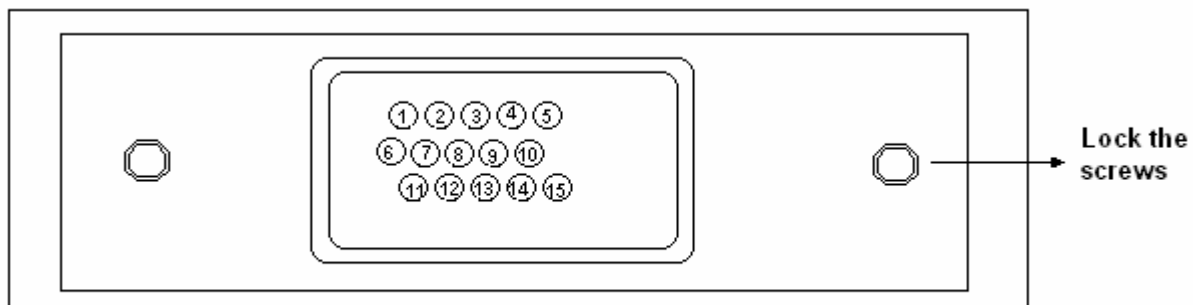



**CONTROLS AND ADJUSTMENTS:**

There are five switches on the control panel. The adjustable controls allow the best display status for individual requirements.

**1.0 Key Function.**

**1. OSD / EXIT**

OSD – Call the Main-Menu OSD

**2. FUN – / FUN +**

When the Main-Menu is displayed, you can select each function using these keys

**3. KEY - / KEY +**

When the Sub-Menu is displayed, you can change the amplitude of The selected function of the screen using these keys.

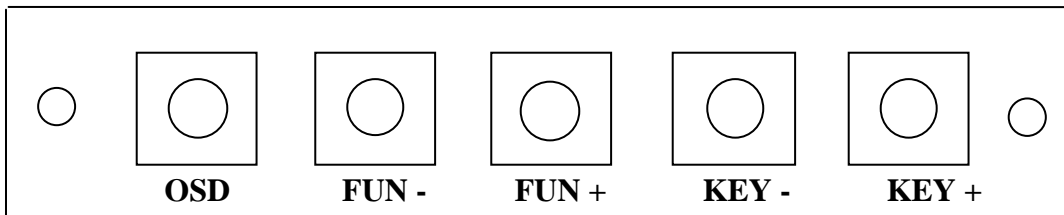

**USER O.S.D. CONTROL**

| Location                     | Adjustment Method                            | Function  |
|------------------------------|--|---|
| CUSTOMER CONTROL PCB         | OSD CONTROL                                  | Brightness<br>Contrast<br>Horizontal Position<br>Vertical Position<br>Horizontal Size<br>Vertical Size<br>Side Pincushion<br>Trapezoid<br>Pin Balance<br>Parallelogram<br>OSD Time<br>Degauss<br>RGB screen Color |
| Main PCB<br>Factory Adjusted | VR control : VR501, VR601<br>VR202,VR201 FBT | H Size -H-Cen, Fil, B+ Adj - Focus and Screen   |

\* Note : ( Factory adjusted and epoxyed VR501 VR601) ( Hot melted screen FBT)  
OSD User Controls

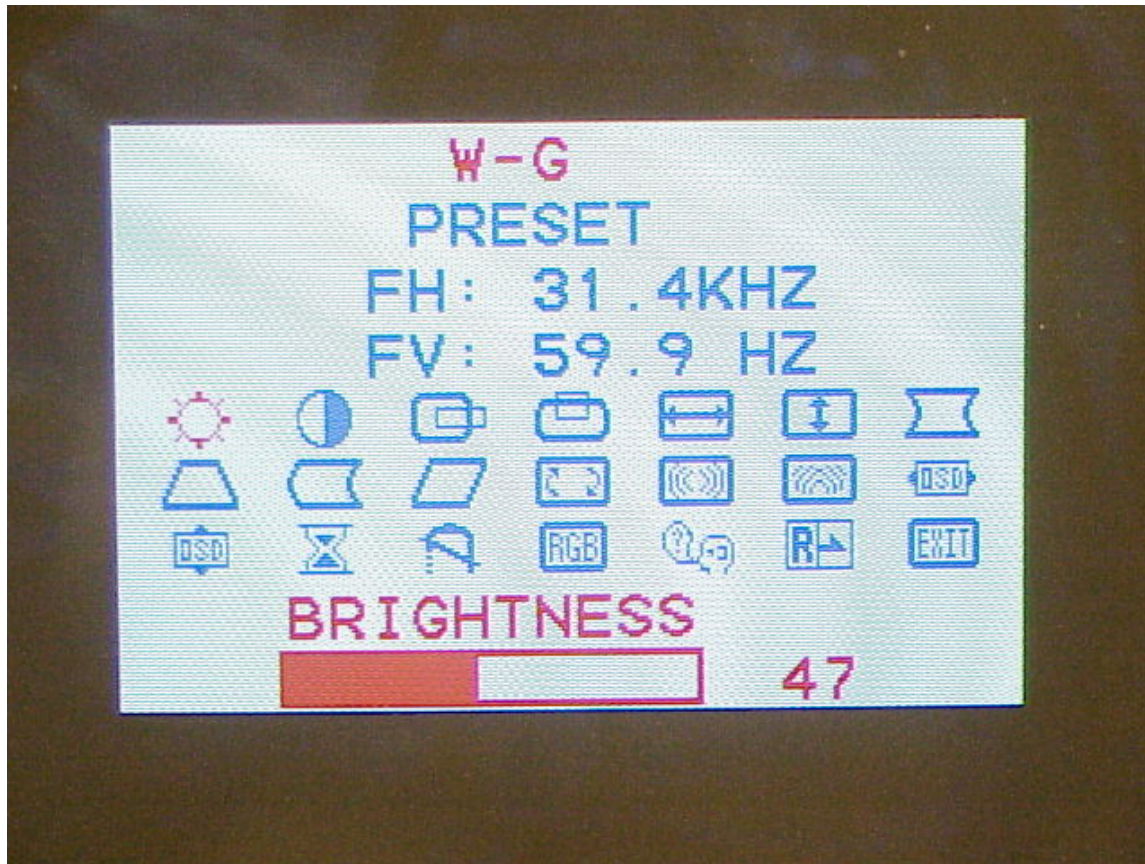

**A. ADJUSTMENT PROCEDURE .  
BRIGHTNESS ADJUSTMENT**

- 1) Press the “OSD” key The Main-Menu OSD will come up as pictured above.
- 2) Search “BRIGHTNESS” sub-menu using “+ or - FUN” key on the Main-Menu OSD.
- 3) The “BRIGHTNESS” OSD color changes from blue to red.
- 4) Adjust Brightness as much as you want using “+ or -” key.
- 5) After finishing the Brightness adjust, press the “OSD ” key. The “OSD” will Disappear. The new Brightness value will be saved automatically.
- 6) If you want to adjust other functions (sub-menu), search the function using “+ or -” keys, and then repeat the same procedures of steps 2-5. See next page.
- 7) Press the “OSD” key again to finish adjustments and the OSD will disappear. If no action is taken in the OSD, the menu will disappear by itself.



## OTHER “OSD” ADJUSTMENTS

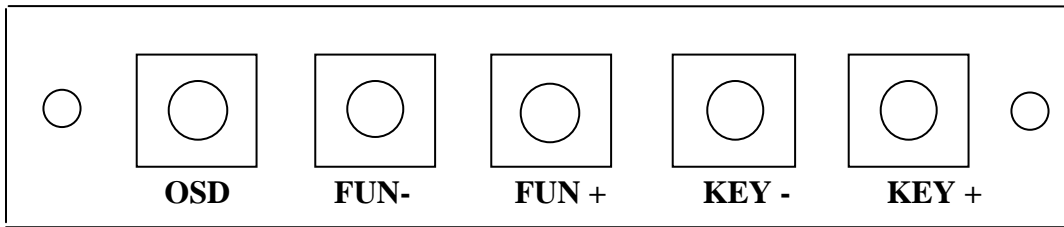

## OSD MENU AND USER FUNCTIONS.

- |   |  |            |               |
|---|--|------------|---------------|
| • | CONTRAST - PICTURE CONTROL   | ADJUSTMENT | SAME ABOVE    |
| • | H. POSITION - SCREEN POSITION  | ADJUSTMENT | SAME ABOVE    |
| • | V. POSITION - SCREEN POSITION  | ADJUSTMENT | SAME ABOVE    |
| • | H. SIZE - SCREEN SIZE  | ADJUSTMENT | SAME ABOVE    |
| • | V. SIZE - SCREEN SIZE  | ADJUSTMENT | SAME ABOVE    |
| • | PINCUSHION - SCREEN GEOMETRY   | ADJUSTMENT | SAME ABOVE    |
| • | TRAPEZOID - SCREEN GEOMETRY  | ADJUSTMENT | SAME ABOVE    |
| • | PIN BALANCE (BOW)- SCREEN GEOMETRY   | ADJUSTMENT | SAME ABOVE    |
| • | PARALLEL - SCREEN GEOMETRY   | ADJUSTMENT | SAME ABOVE    |
| • | TILT - SCREEN ROTATION   | ADJUSTMENT | SAME ABOVE    |
| • | HORIZONTAL MOIRE   | OPTIONAL   | FUNCTION      |
| • | VERTICAL MOIRE   | OPTIONAL   | FUNCTION      |
| • | OSD - HORIZONTAL POSITION  | ADJUSTMENT | SAME ABOVE    |
| • | OSD - VERTICAL POSITION  | ADJUSTMENT | SAME ABOVE    |
| • | OSD - TIME   | ADJUSTMENT | SAME ABOVE    |
| • | DEGAUSS - SCREEN COLOR PURITY  | ADJUSTMENT | SAME ABOVE    |
| • | COLOR SCREEN - COLOR PREFERENCE  | ADJUSTMENT | SEE NEXT PAGE |
| • | LANGUAGE - OSD LANGUAGE<br>The menu is available in NINE POPULAR languages   | ADJUSTMENT | SEE NEXT PAGE |
| • | RECALL - RECALL FACTORY ADJUSTMENTS<br>When the “RECALL” key is pressed, all user’s adjustment values are changed to the factory values. | ADJUSTMENT | SEE ABOVE     |





## COLOR SUBMENU RGB

### SCREEN COLOR - COLOR PREFERENCE

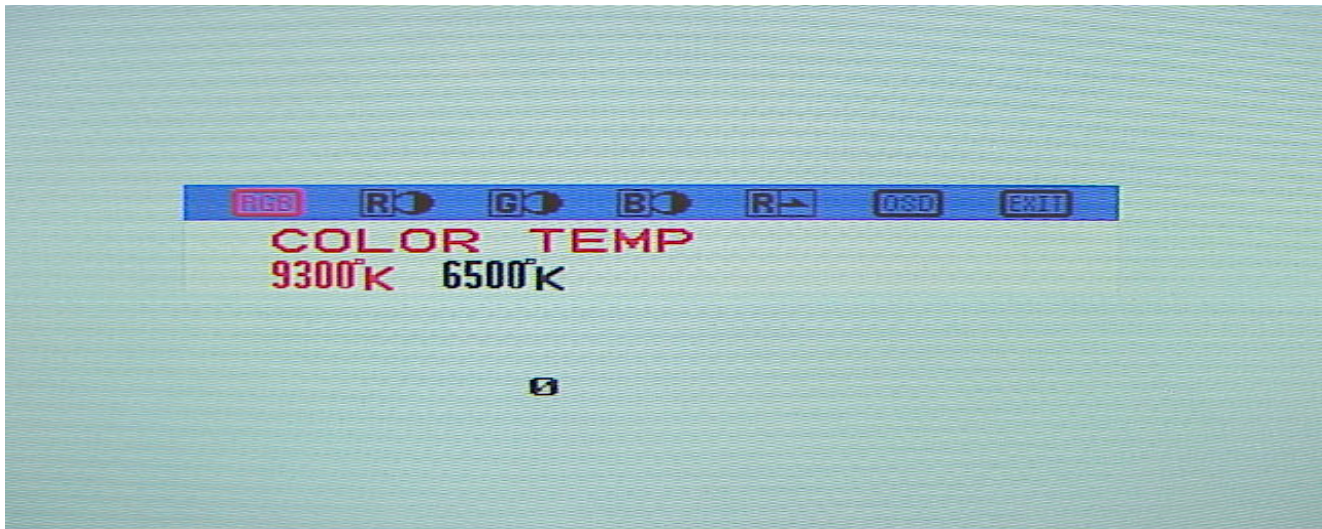

- **COLOR ADJUSTMENT. Factory preset.**  
COLOR 1 - 9300°K: X=0.285, Y=0.293  
COLOR 2 - 6500°K: X=0.312, Y=0.329

### COLOR ADJUSTMENT - USER PREFERENCE

- 1) Press the “OSD” button to show the Main-Menu OSD.
- 2) Search the “RGB - ICON” sub-menu by using “+ or - Key” key on the Main-Menu OSD.
- 3) **SELECT** the “RGB” by pressing “+ Key”. The color Sub-Menu OSD appears as Shown by the figure below. **RGB BOX WILL BE FLASHING RED.**
- 4) Press “+ or- KEY” to select COLOR 1 ( Cool color ) or COLOR 2 ( Warm color)  
Press “+ or - FUN” to select “RED”, “GREEN” or “BLUE” for adjustment to the User’s preference. The “ + or- KEYS ” will adjust the selected RED, GREEN, BLUE Color on the viewing screen. The selected item will change the OSD color and the White Screen from white to the users preference.
- 5) The box labeled R→ Will return the changed settings to the factory preset values if desired
- 6) Using the “+ or- KEY” to select the “ OSD ” box will return the main menu.  
Using the “+ or- KEY” to select the “ EXIT ” box will turn off the menu.  
( Exit and save. Save is automatic)



## LANGUAGE - USER PREFERENCE

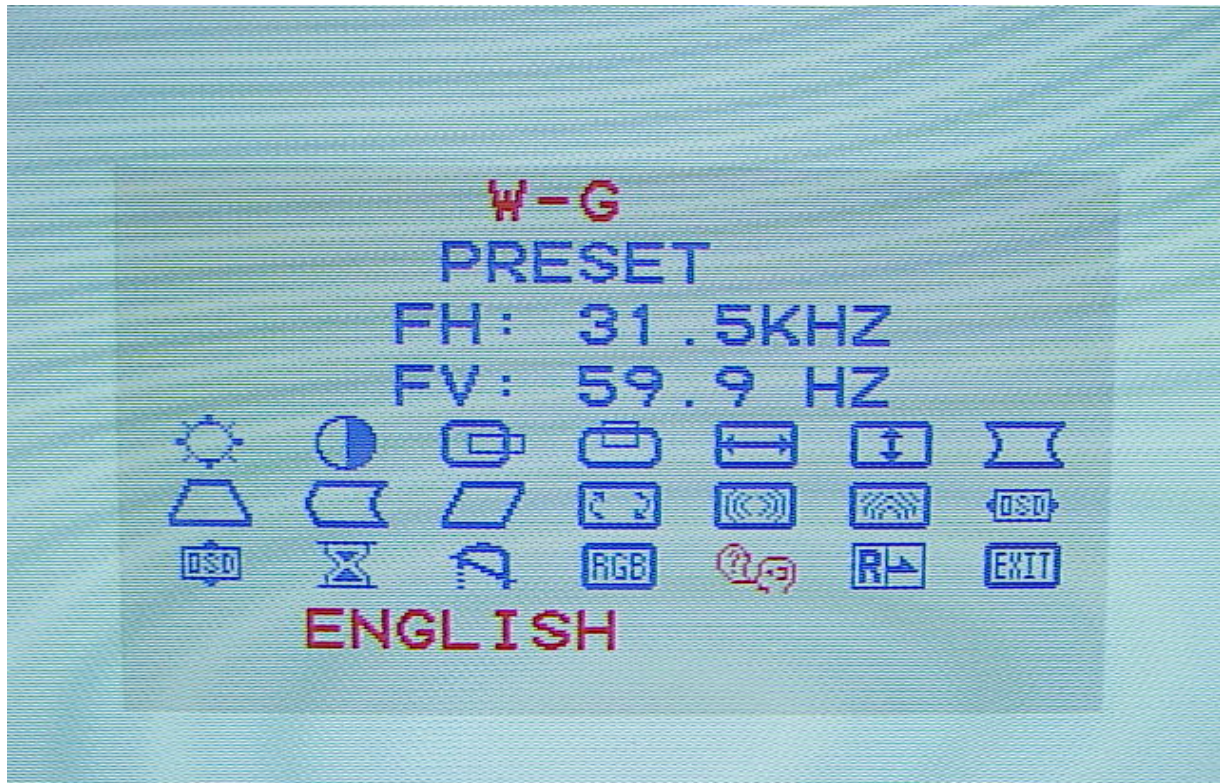

## LANGUAGE SELECTION - USER PREFERENCE

- 1) Press the “OSD” button to show the Main-Menu OSD.
- 2) SELECT the “LANGUAGE - ICON” by pressing “+ FUN” Key. The language Sub-Menu OSD appears as Shown by the figure above. The language BOX WILL BE FLASHING RED.
- 3) Press “+ or - KEY” to select one of the desired languages for the users Preference. This menu is available in nine languages.
- 4) Press the “OSD” button to turn off the Menu (OSD).  
If no action is taken in the OSD, the menu will disappear by itself.  
( Exit and save. Save is automatic)





**TIMING CHART:**

**5 Standard Factory Pre-Set Timing Modes.**

Can be set to any customer requirement of 15.75-40Khz hor and 40-100Hz vert.

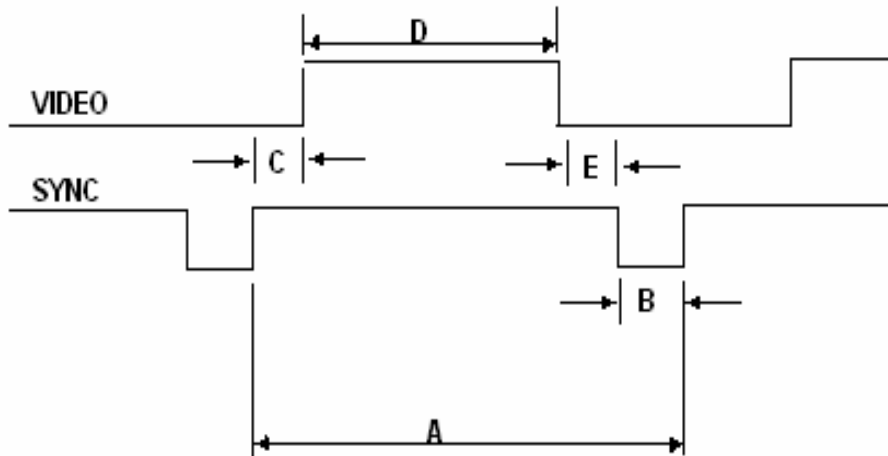

Timing shown is based on 801GC/GX signal generator

|                   | CGA<br>640X240 | MID- RES<br>773X384 | Mode 3<br>640X480<br>VGA_M3 | Mode4<br>720X400<br>VGA_2 | Mode 5<br>800X600<br>VG900602 |
|-------------------|----------------|---------------------|-----------------------------|---------------------------|-------------------------------|
| <b>HORIZONTAL</b> |                |                     |                             |                           |                               |
| Scan freq.        | 15.725kH       | 24.394kHz           | 31.469kHz                   | 31.469Khz                 | 37.879KHz                     |
| scan per.         | 63.594us       | 41.00us             | 31.777us                    | 31.777us                  | 26.00us                       |
| sync pulse        | 4.688us        | 3.00us              | 3.813us                     | 3.813us                   | 3.200us                       |
| front porch       | 2.187us        | 2.910us             | 0.636us                     | 0.636us                   | 1.000us                       |
| active vid.       | 50.00us        | 30.690us            | 25.422us                    | 25.422us                  | 20.000us                      |
| back porch        | 6.719us        | 4.440us             | 1.906us                     | 1.906us                   | 2.200us                       |
| sync polarity     | ( - )          | ( - )               | ( - )                       | ( - )                     | ( + )                         |
| <b>VERTICAL</b>   |                |                     |                             |                           |                               |
| Vert. scan freq.  | 60.018Hz       | 57.534Hz            | 59.941Hz                    | 70.087Hz                  | 60.317Hz                      |
| scan per.         | 16.662ms       | 17.384m             | 16.683ms                    | 14.268ms                  | 16.579ms                      |
| sync pulse        | 0.191ms        | 0.164ms             | 0.064ms                     | 0.064ms                   | 0.106ms                       |
| front porch       | 0.190ms        | 0.451ms             | 0.318ms                     | 0.318ms                   | 0.02ms                        |
| active vid.       | 15.263ms       | 15.621ms            | 15.253ms                    | 12.711ms                  | 15.840ms                      |
| back porch        | 1.018ms        | 1.148ms             | 1.048ms                     | 1.048ms                   | 0.607ms                       |
| sync polarity     | ( - )          | ( - )               | ( - )                       | ( + )                     | ( + )                         |



**Wells-Gardner Electronics Corporation**



**Wells-Gardner Electronics Corporation**